

PETKIT™

USER MANUAL

PETKIT YUMSHARE DUAL-HOPPER WITH CAMERA
SMART PET FEEDER

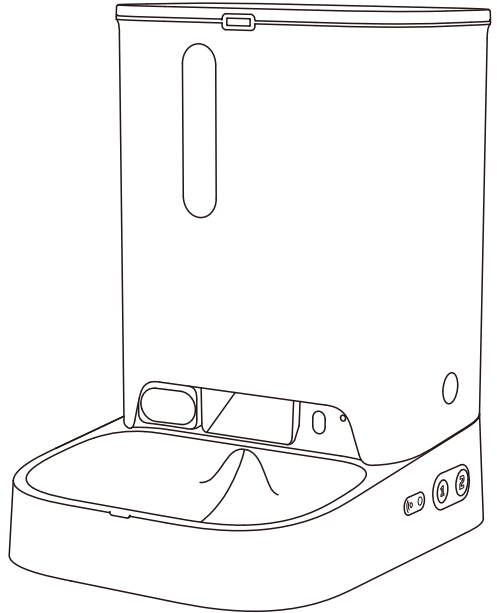

Please read the User Manual carefully
before using the product and keep it
properly.

V1.0-2023.08

TABLE OF CONTENTS

PRODUCT LIST	3
PRODUCT DESCRIPTION	4
PRODUCT INSTALLATION	6
HOW TO USE	8
DESCRIPTION OF APP FUNCTIONS	13
CLEANING AND MAINTENANCE	26
VIDEO GUIDE	27
BASIC SPECIFICATIONS	28
A MESSAGE TO OUR VALUED CUSTOMERS	29
USER SAFETY GUIDE	29

01 PRODUCT LIST

* Please confirm the following accessories are complete before installation and use.

(Batteries or screwdriver are not equipped and need to be purchased separately)

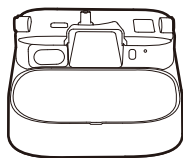

Main Unit

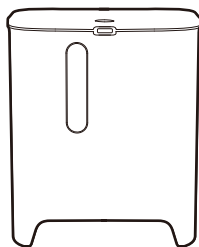

Hopper

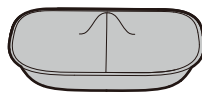

Stainless Steel
Food Bowl

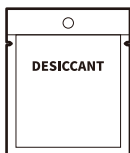

Desiccant

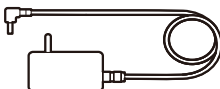

Adapter



User Manual

02 PRODUCT DESCRIPTION

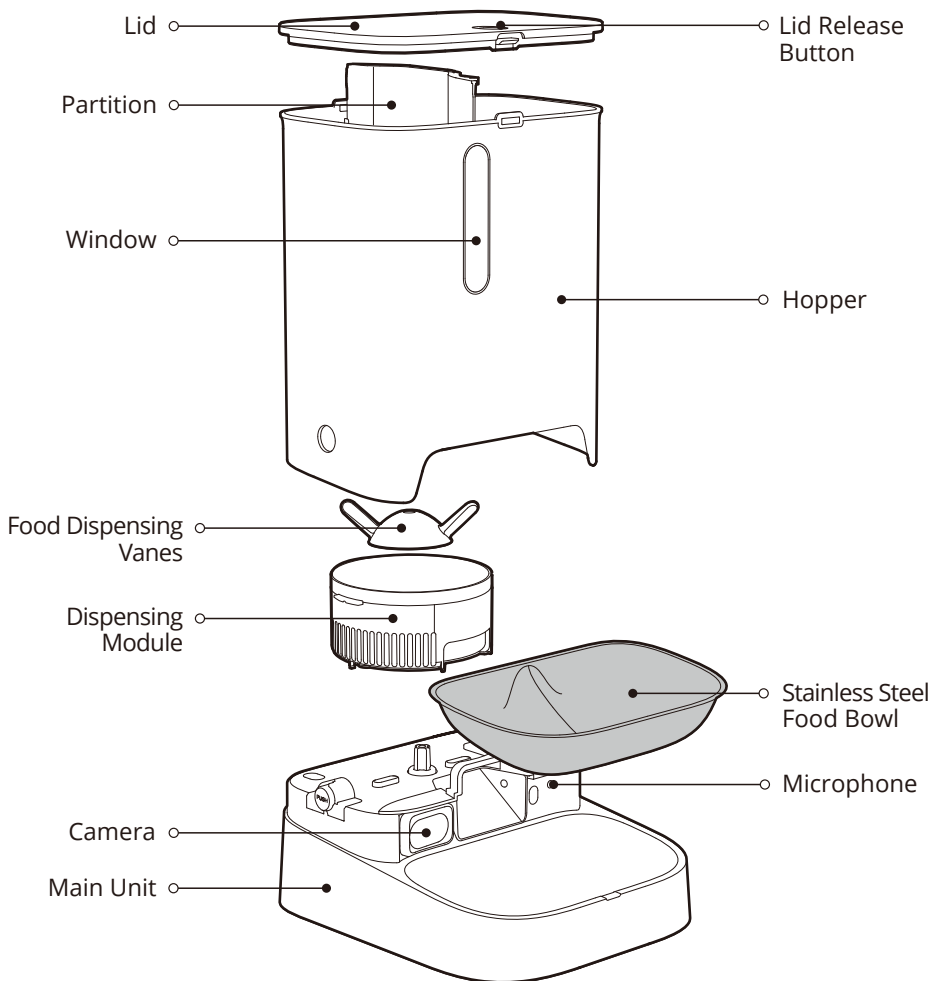

* Note: in order to provide a better user experience, we will be implementing periodic product enhancements. Product images shown for illustration purpose only. Actual product may vary from the image shown on the box. For any discrepancies, please refer to the actual product.

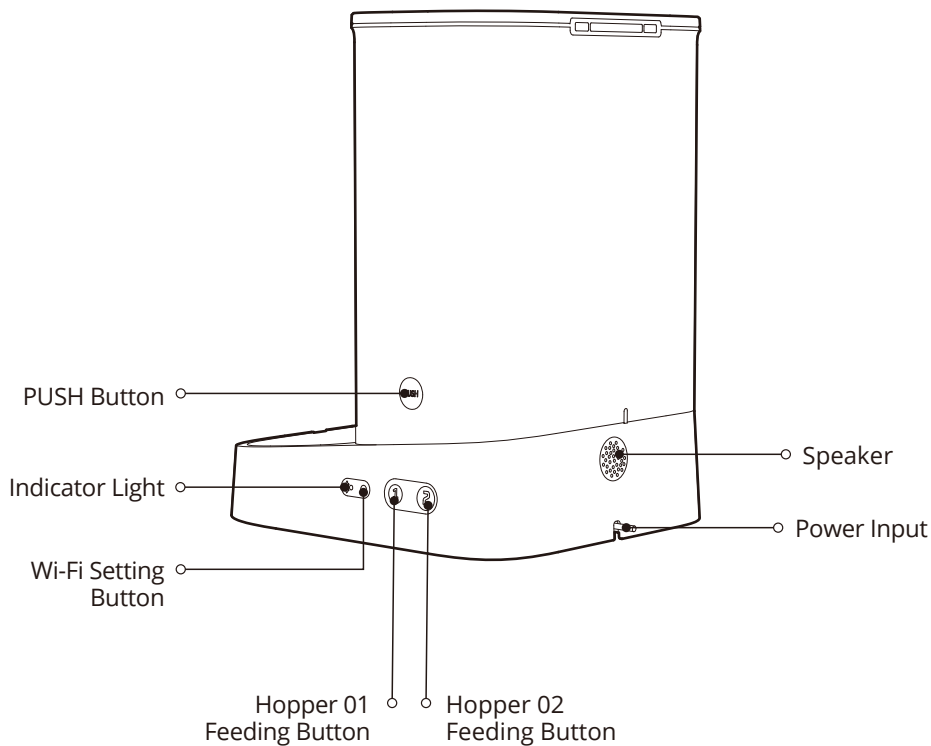

03 PRODUCT INSTALLATION

3.1 Installing the Main Unit

- ① Place the main unit on the level ground or desk.
- ② Lift the hopper, align the notches on both sides with the PUSH button on the main unit, and place it vertically downwards.
- ③ Press and hold the PUSH buttons until they are fully stuck into the notches.
- ④ Place the stainless steel food bowl in the food bowl holder.

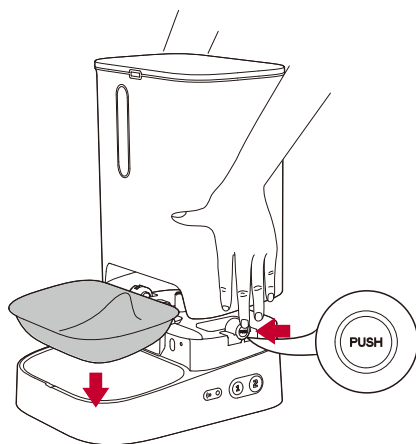

3.2 Connecting the Power Supply

Take out the power adapter cord and attach it to the power input on the back.

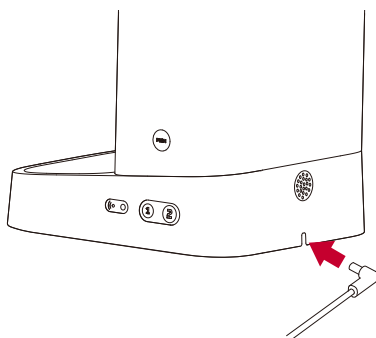

3.3 Installing the Backup Batteries

- ① Take out the screw and remove the battery cover.
 - ② Take four D alkaline batteries and place them in the battery compartment. (Pay attention to the orientation of the positive and negative ends)
 - ③ Put the battery cover back on and tighten down the screw.
- Choose whether to install batteries based on personal actual usage needs.
(Batteries need to be purchased separately, and only alkaline batteries can be used)

*** Note: When the battery is low, please replace the batteries in time. Check and replace the batteries before leaving the device unattended for an extended period of time.**

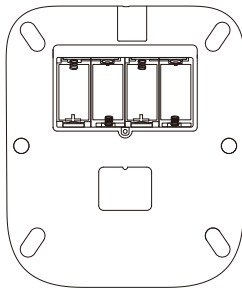

Bottom of the main unit

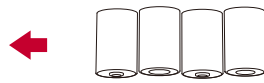

D alkaline batteries *4

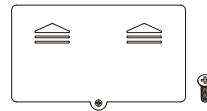

Battery cover

3.4 Installing the Desiccant

- ① Press and hold the lid release button to the right and lift up to remove the lid.
- ② Open the desiccant compartment, take the desiccant packet, and lay it down evenly in the compartment, Then close the desiccant.

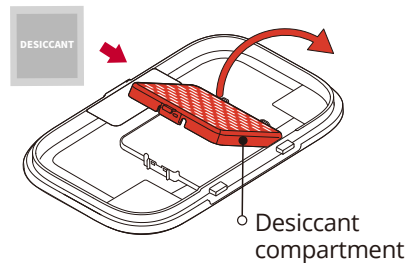
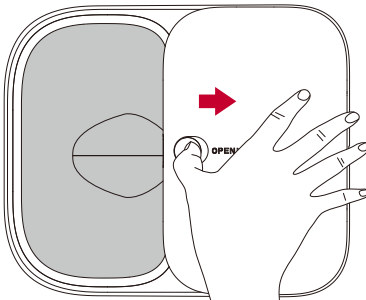

Interior of the lid

04 HOW TO USE

4.1 Adding Pet Food

① Add pet food. (Do not exceed the MAX line) Two different pet foods can be placed in hopper 01 and hopper 02 according to your feeding needs.

* **Note: Do not pull out the partition if there is food left inside.**

* **Recommended kibble size of dry food $\leq 12\text{mm}$ (0.47in)**

* **Recommended kibble size of freeze-dried food $\leq 9\text{mm}$ (0.35in)**

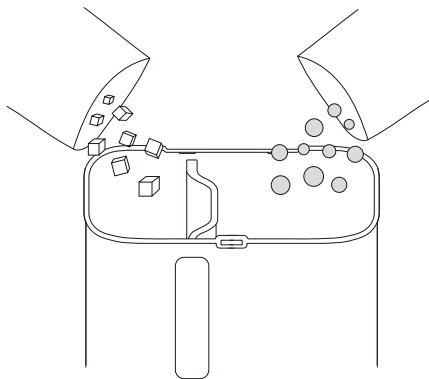

② Cover the lid: Insert the rear side of the lid into the two holes above the hopper.

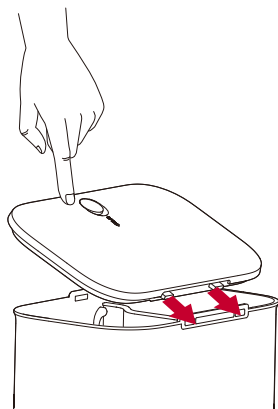

4.2 Indicator Light

The indicator light can be turned on/off in the App.
The indicator light is not on in battery mode.

Indicator light	Status
White light is flashing slowly	Device is not connected to Wi-Fi
White light is flashing quickly	Device is connecting to Wi-Fi
White light is constantly on	Device is connected to Wi-Fi (Camera is not working)
Green light is constantly on	Device is connected to Wi-Fi (Camera is working)

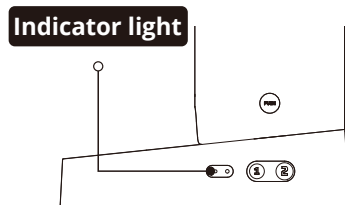

4.3 Manual Feeding

Select 01 or 02 hopper button.
Press the button to start dispensing;
Release the button to end dispensing.

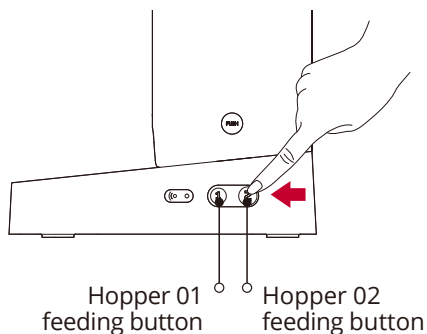

4.4 App Binding and Activation

① Download and install PETKIT App:

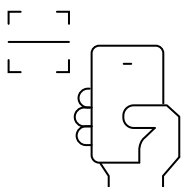

Download the PETKIT App in an App Store or Android Stores

② Add a device

Open the PETKIT App and enter its homepage; click “+” on the top right corner of the page to select and add the “PETKIT YUMSHARE DUAL-HOPPER WITH CAMERA”.



* Note: To provide the best possible user experience and functional optimization, the product firmware will be irregularly upgraded. Please refer to actual situations and promptly upgrade the firmware via PETKIT App.

③ Start connection

In the startup state, long press the Wi-Fi setup button for 5 seconds until the indicator light on the device flashes rapidly; click Next to configure Wi-Fi and the App will start to connect to the device. Please wait until the App displays configuration succeeds.

*** This product supports 2.4GHz Wi-Fi, but not 5GHz. Please make sure you have turned on the 2.4 band when connecting the device to the Internet.**

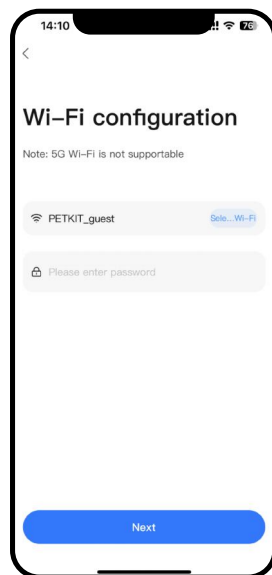
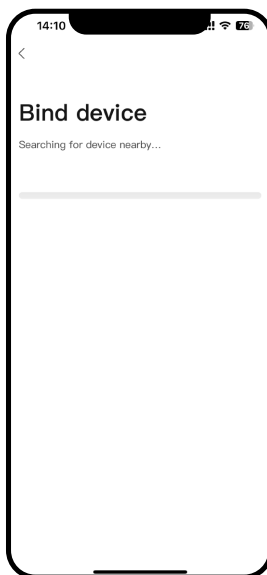
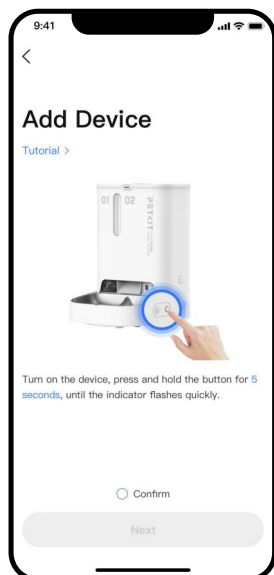

* Note: To provide the best possible user experience and functional optimization, the product firmware will be irregularly upgraded. Please refer to actual situations and promptly upgrade the firmware via PETKIT App.

④ Read usage guidelines

After the device successfully connects to the PETKIT App for the first time, to ensure pet safety and proper use of the product, please carefully read the usage guidelines and appropriately use the product according to the instructions.



* Note: To provide the best possible user experience and functional optimization, the product firmware will be irregularly upgraded. Please refer to actual situations and promptly upgrade the firmware via PETKIT App.

05 DESCRIPTION OF APP FUNCTIONS

5.1 Device Homepage

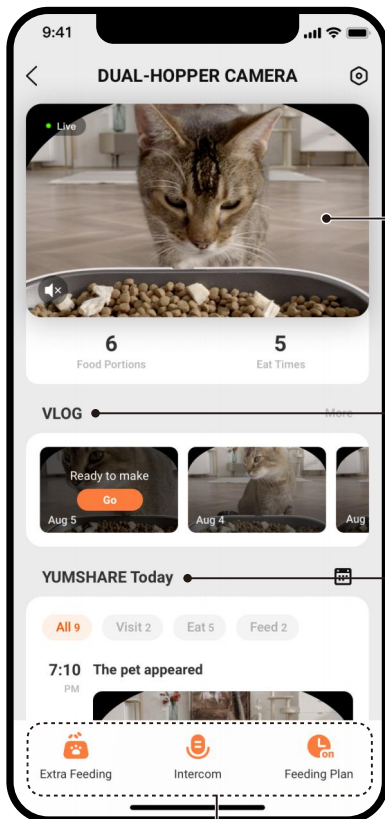

① **Real-time video:**
View your pet's status in real-time.

② **VLOG:**
Click " **Go** ", and the system will automatically generate vlogs of your pet. This section displays up to the last 7 days of video.

③ **YUMSHARE today (Timeline):**
Clips captured are categorized as visit, eat, and feed through AI algorithm. You can click any of them for more details.

*** Only pictures can be viewed when PETKIT Care+ Cloud Service is not subscribed. Please subscribe the Service if you want such functions as playing back full clips, moments and speedup playback. For specific rules, please refer to PETKIT Care+ Service Agreement.**

④ **Function keys**

* Note: To provide the best possible user experience and functional optimization, the product firmware will be irregularly upgraded. Please refer to actual situations and promptly upgrade the firmware via PETKIT App.

④ Description of function keys



Extra feeding

Click it to dispense food for your pets instantly.
(Remote control is supported.)

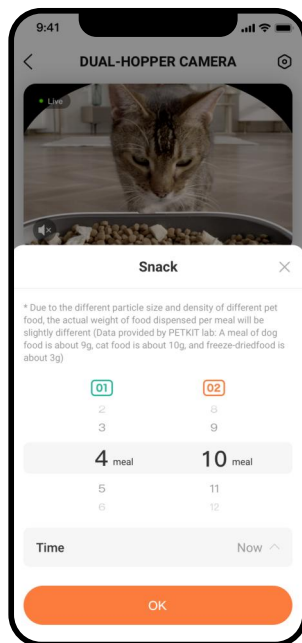

Intercom

Long press "Intercom", and the feeder will broadcast what you said simultaneously, so as to have dialogues with your pets in real time.

⚠ Your voice is only heard when playing back videos. (You need to turn on the microphone first via the App.)

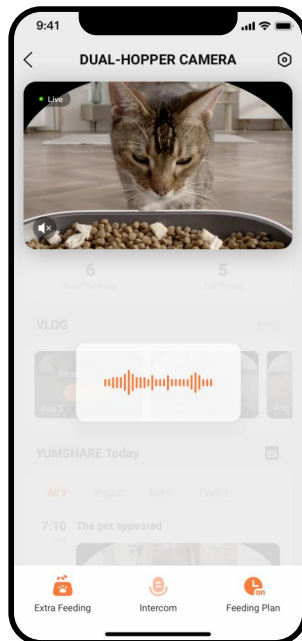

* Note: To provide the best possible user experience and functional optimization, the product firmware will be irregularly upgraded. Please refer to actual situations and promptly upgrade the firmware via PETKIT App.



Feeding plans

Set up the feeding time and portions to make sure your pet is fed on time.

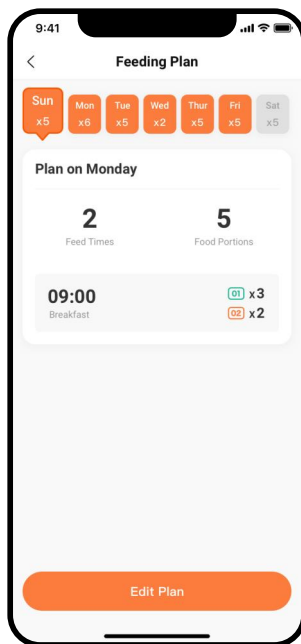

* Note: To provide the best possible user experience and functional optimization, the product firmware will be irregularly upgraded. Please refer to actual situations and promptly upgrade the firmware via PETKIT App.

5.2 Play Videos

After subscribing the PETKIT Care+ Cloud Service, click the Timeline on the homepage of the device to play back full clips, highlight with speedup options.

① Highlight playback

You can preview 4-second videos that are sped up by clicking them in the Timeline.

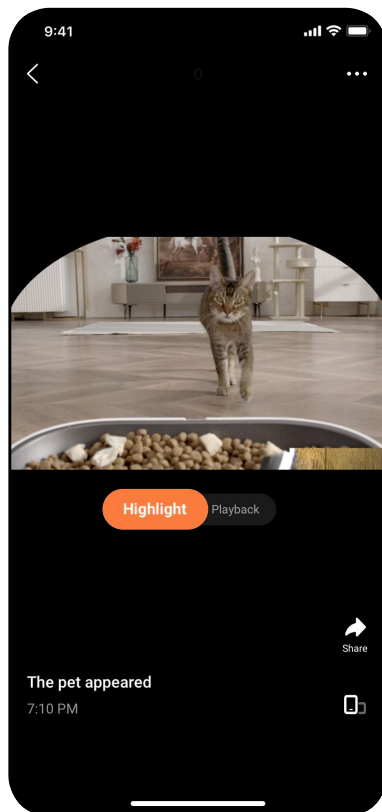
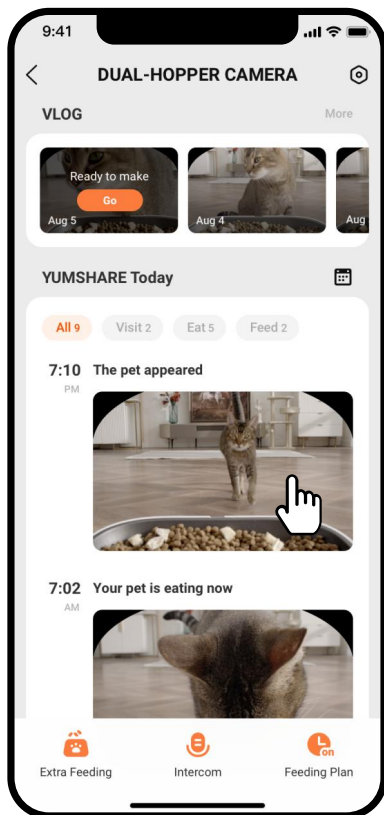

* Note: To provide the best possible user experience and functional optimization, the product firmware will be irregularly upgraded. Please refer to actual situations and promptly upgrade the firmware via PETKIT App.

② Full clips playback

Switch the tag to "Playback" to watch complete video clips.

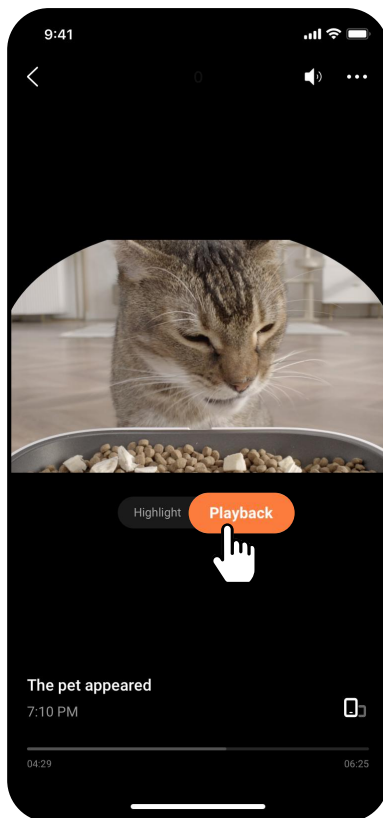

* Note: To provide the best possible user experience and functional optimization, the product firmware will be irregularly upgraded. Please refer to actual situations and promptly upgrade the firmware via PETKIT App.

③ Speedup playback

When playing full video clips, click "⋮" on the top right corner to choose the speed as needed, or long press the center of video frame to directly switch to 2x play.

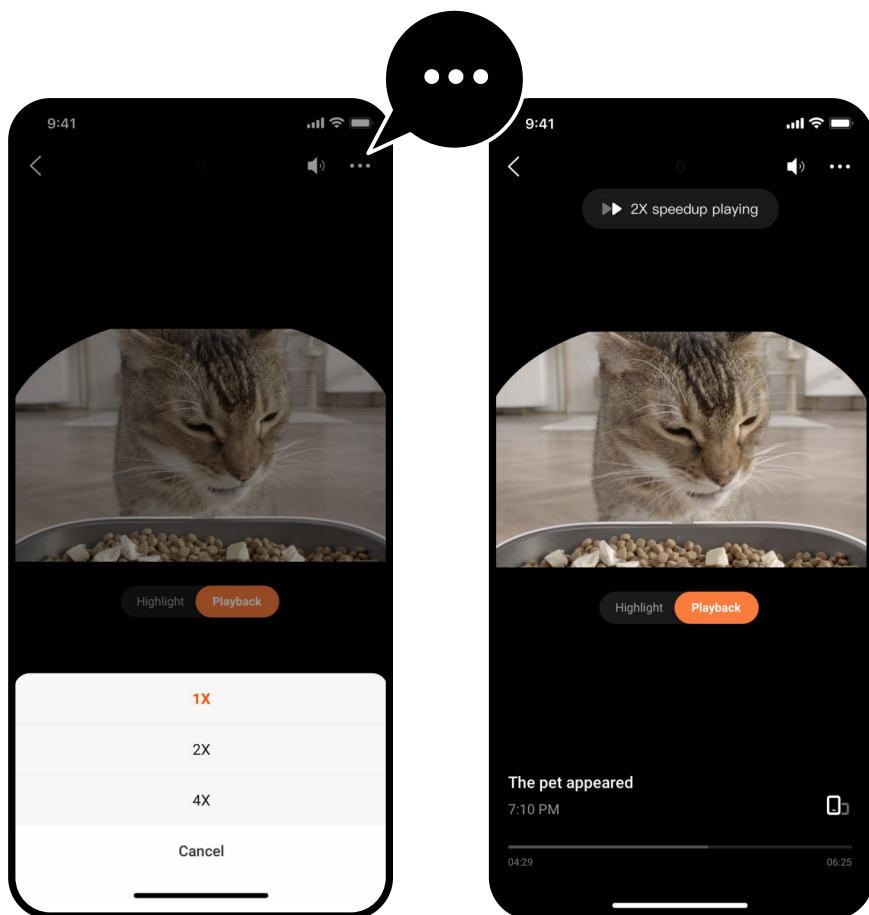

* Note: To provide the best possible user experience and functional optimization, the product firmware will be irregularly upgraded. Please refer to actual situations and promptly upgrade the firmware via PETKIT App.

5.3 Delete Video Clips

You are entitled to delete any video.

① Method 1:

Delete videos in the Timeline;

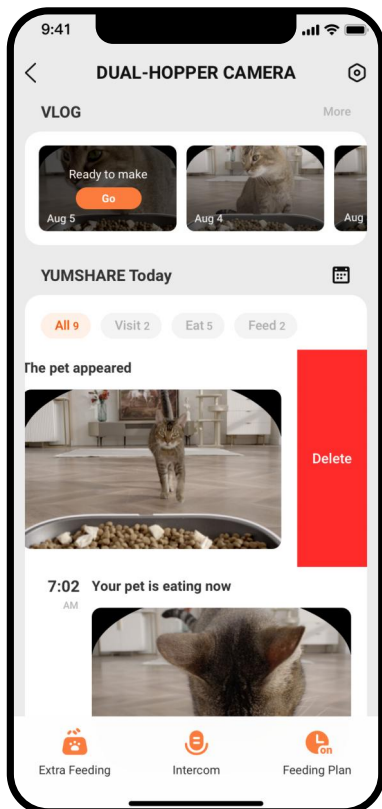

② Method 2:

Delete videos in VLOG. Click the video you want to remove, turn its play tag to "Full" and click the "⋮" on the top right corner to delete the video.

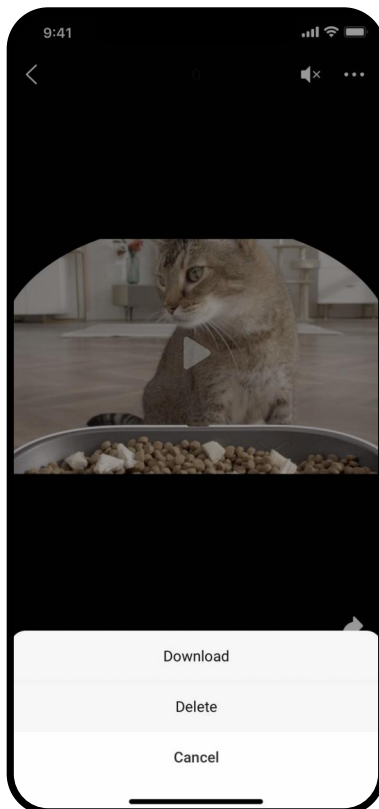

* Note: To provide the best possible user experience and functional optimization, the product firmware will be irregularly upgraded. Please refer to actual situations and promptly upgrade the firmware via PETKIT App.

5.4 Privacy Protection

① Camera permissions

You are entitled to turn the camera on or off as needed.

! If it is turned off, any video footage fails to be captured.

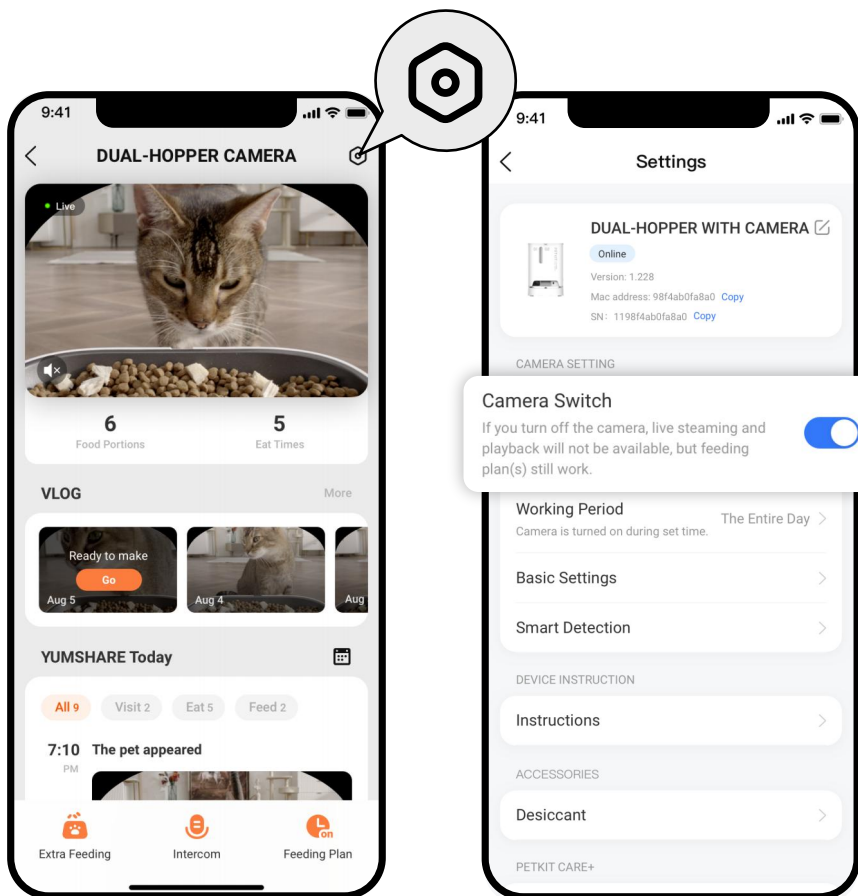

* Note: To provide the best possible user experience and functional optimization, the product firmware will be irregularly upgraded. Please refer to actual situations and promptly upgrade the firmware via PETKIT App.

(1) Customize the detection time periods of the camera

You can personalize the time slots to turn on the camera, and beyond those, the camera is turned off automatically.

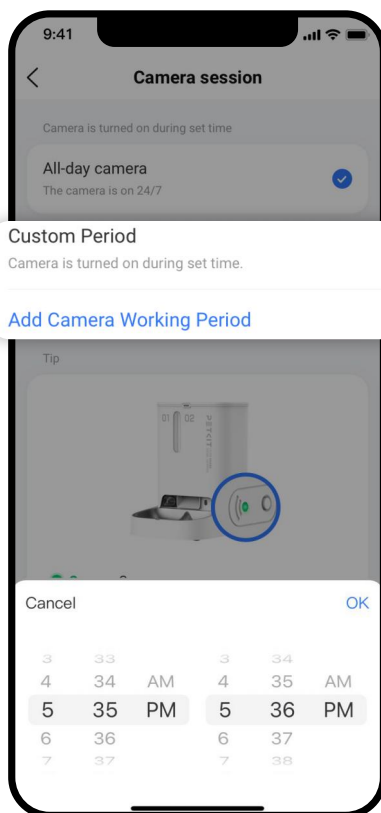
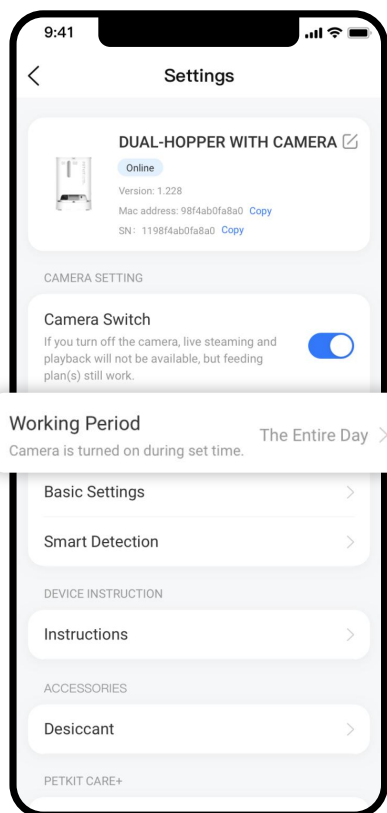

* Note: To provide the best possible user experience and functional optimization, the product firmware will be irregularly upgraded. Please refer to actual situations and promptly upgrade the firmware via PETKIT App.

(2) Indicator light status

When the camera is turned on, the light is green; when off, the light is white.

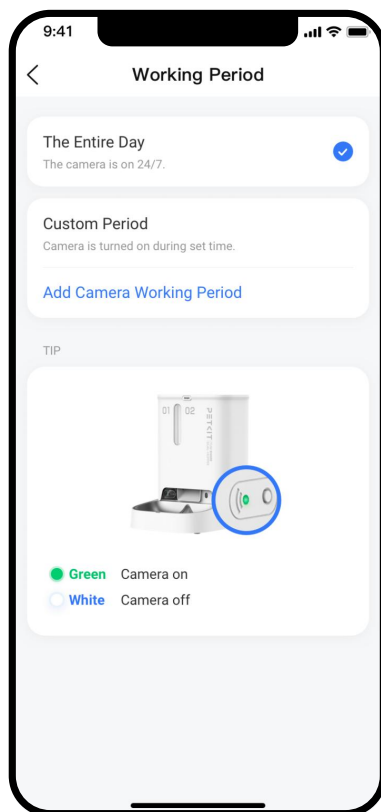

* Note: To provide the best possible user experience and functional optimization, the product firmware will be irregularly upgraded. Please refer to actual situations and promptly upgrade the firmware via PETKIT App.

② Microphone permissions

You are entitled to turn on or off the microphone as needed.

! If it is turned off, there is no sound for any video footage.

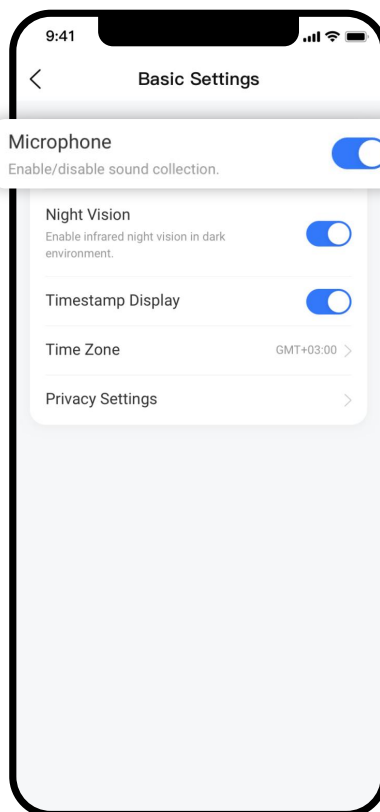
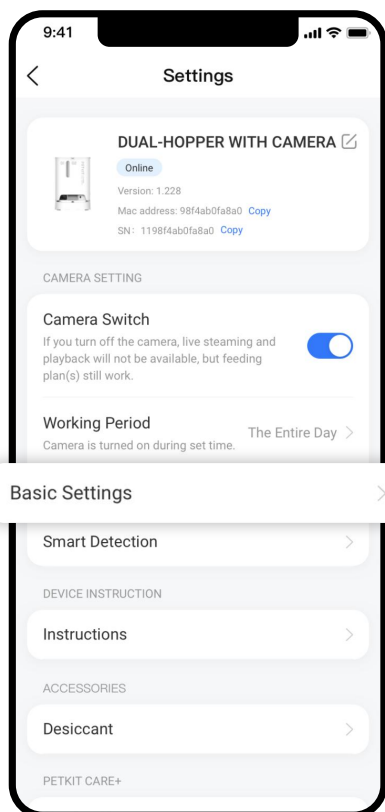

* Note: To provide the best possible user experience and functional optimization, the product firmware will be irregularly upgraded. Please refer to actual situations and promptly upgrade the firmware via PETKIT App.

③ Real-time frame privacy protection

After this function is turned on, any real-time video frame will be blurred to protect your privacy when you enter the device homepage.

Real-time video frame

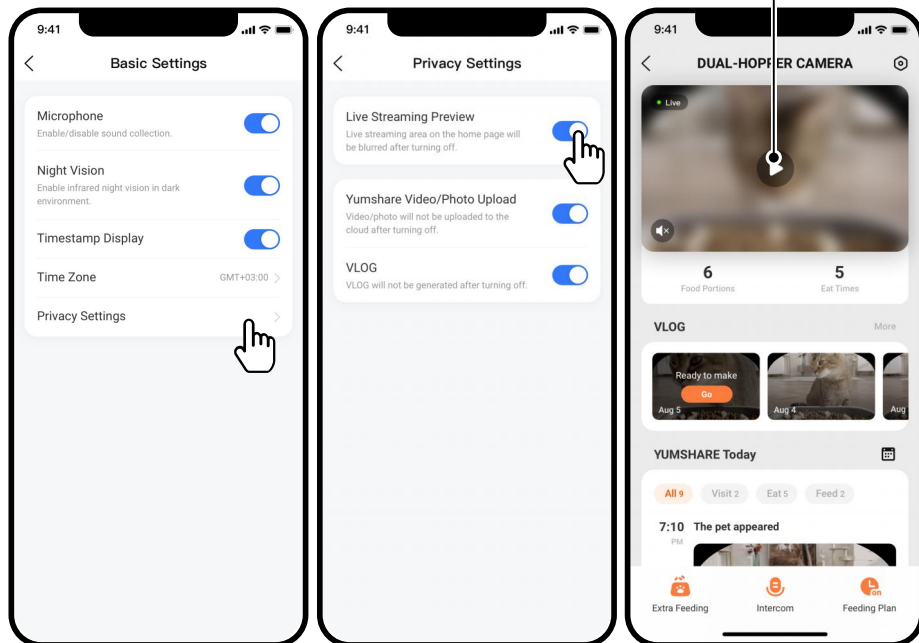

* Note: To provide the best possible user experience and functional optimization, the product firmware will be irregularly upgraded. Please refer to actual situations and promptly upgrade the firmware via PETKIT App.

5.5 Additional Notes

① Cyclic videos stored in the Cloud

The playback contents are based on time-limited cyclic storage, and the data outside the time limit is periodically cleared. All videos can be downloaded and viewed in your phone's local and App albums. (e.g. 7-day video loop means that the videos or pictures stored in the last 7 days will be retained except for today's and meanwhile the contents of the day before the last 7 days will be automatically cleared.)

② PETKIT Care+ Cloud Service

You can purchase the Service for every feeder with camera via the App to enjoy such services as pet detection, playing back full HD video stored in the Cloud and HD Moments, which are subject to actual description. Multiple purchases of the Service are supported. PETKIT staff will provide you service upgrade or extension according to the attributes of the service you have bought. The Cloud Service is allowed to be transferred to another device for once a year. Please note that the Cloud Service is a virtual product so that it is not refundable once purchased.

 [Click to check items of PETKIT Care+ Cloud Service Agreement.](#)

06 CLEANING AND MAINTENANCE

① Open the lid to remove the desiccant, pull out the partition vertically upward, and then remove the food bowl.

② Hold the PUSH buttons on both sides of the main unit with middle fingers, and lift it up at the same time to remove the hopper.

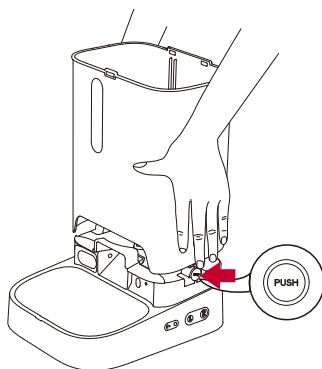
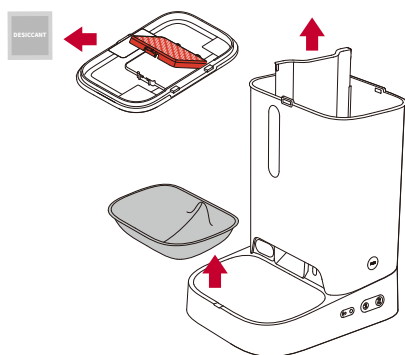

③ Pull out the food dispensing vanes in the hopper. Rotate clockwise to remove the impeller cover and take out the impeller.

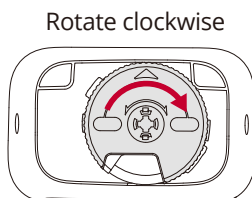
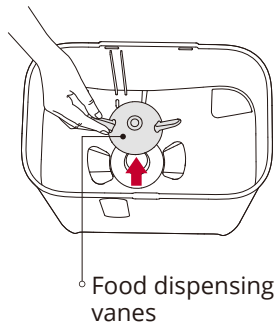

Bottom of the container

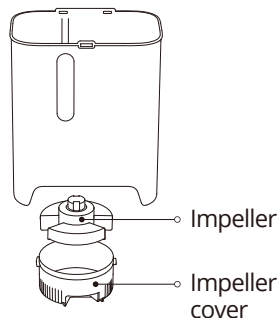

④ Clean the hopper, vanes, impeller cover, impeller, upper lid and food bowl in turn, it is recommended to add appropriate amount of detergent and rinse well.

⑤ After cleaning, wait for each part to dry completely and install them back in turn. (* For detailed steps of cleaning and maintenance, please watch corresponding video.)

⚠ Please be sure to use a sponge or soft cloth to clean the inside of the hopper, do not use hard-material cleaning tools to avoid scratching the plastic parts and affecting the normal operation of the sensor. Main unit cannot be immersed or soaked in water, it can be wiped with a damp tissue.

07 VIDEO GUIDE

7.1 Video of Installation and Usage

Please copy the video URL and open it in your browser to watch the video.

<https://youtu.be/yYALvk-wNhY>

7.2 Video of Cleaning and Maintenance

Please copy the video URL and open it in your browser to watch the video.

<https://youtu.be/gyh2mUKjgLY>

08 BASIC SPECIFICATIONS

Product Name	PETKIT YUMSHARE DUAL-HOPPER WITH CAMERA SMART PET FEEDER
Product Model	P591
Product Material	ABS, 304 Stainless Steel
Product Dimensions	362 *293 *247.5mm (14.2*11.5*9.7in)
Capacity	5L (01 hopper 2L, 02 hopper 3L)
Product Weight	about 2.5kg (5.5lb)
Rated Input	6V === 2A
Rated Power	4W
Wireless Connection	Wi-Fi
Scope of Application	cats and small-breed dogs

Disposal

The European directive 2012 / 19 / CE on Waste Electrical and Electronic Equipment (WEEE), requires that old household electrical appliances must not be disposed in the normal unsorted municipal waste stream. Old appliances must be collected separately in order to optimize the recovery and recycling of the materials they contain and reduce the impact on human health and the environment. The crossed out "wheeled bin" symbol on the product reminds you of your obligation, that when you dispose of the appliance it must be separately collected. Consumers should contact their local authority or retailer for information concerning the correct disposal of their old appliance.

10 A MESSAGE TO OUR VALUED CUSTOMERS

- Thank you for choosing to purchase PETKIT YUMSHARE DUAL-HOPPER WITH CAMERA SMART PET FEEDER.
- Please carefully read the User Manual before using the product. By setting up and using this product, you are acknowledged that you have already read and accepted the safety guidelines listed below.
- We are not liable and will not accept responsibility for any accidents or injuries that result from improper use of this product.
- PETKIT reserves the rights of interpretation and revision.

11 USER SAFETY GUIDE

*** Failure to follow the safety guides outlined below can result in product malfunction or other unforeseen mishaps.**

- Please install and use the product as instructed in the User Manual.
- Pets under three months of age are not recommended to use this product.
- Do not scratch or polish the camera with sharp objects.
- For indoor use only. Do not expose the product directly to sunlight for extended periods of time. Do not place it near an open flame.
- The device is using low voltages. However, pets can still cause electrical leakage if they chew on power cord. Please guide your pets use the product properly.
- Please use the original adapter, otherwise it may damage the device or cause safety hazards.
- Make sure the device is placed on a level surface. Do not overturn the device, or it may not function properly.
- Do not drop all items expect dry pet food into the food storage container, or the device will not function properly, and it may even endanger the safety of the pet.
- In order to prevent your pet from overturning this device, we recommend placing it in a corner or against a wall.
- To prevent the device from falling down and injuring your pet or damaging property, please do not place this device in an elevated location.
- The main unit of the product is prohibited from soaking or submerging in water, and the machine should not be used in damp environments.
- If you want to stop using the device, make sure to remove the battery and unplug the power adapter, and please clean and dry the device before storing.
- Please unplug the power cord before moving the device.
- Children should use this product under the guidance of adults.
- Repairs should be done under the guidance of a professional to avoid safety hazards.
- If you need to go out, please check the battery in the battery compartment to make sure the battery has sufficient charge (this device can only use alkaline batteries).

This device complies with part 15 of the FCC Rules. Operation is subject to the following two conditions:

- (1) This device may not cause harmful interference, and
- (2) this device must accept any interference received, including interference that may cause undesired operation.

FCC warning:

Any changes or modifications not expressly approved by the party responsible for compliance could void the user's authority to operate the equipment.

Note: This equipment has been tested and found to comply with the limits for a Class B digital device, pursuant to part 15 of the FCC Rules. These limits are designed to provide reasonable protection against harmful interference in a residential installation. This equipment generates uses and can radiate radio frequency energy and, if not installed and used in accordance with the instructions, may cause harmful interference to radio communications. However, there is no guarantee that interference will not occur in a particular installation. If this equipment does cause harmful interference to radio or television reception, which can be determined by turning the equipment off and on, the user is encouraged to try to correct the interference by one or more of the following measures:

- Reorient or relocate the receiving antenna.
- Increase the separation between the equipment and receiver.
- Connect the equipment into an outlet on a circuit different from that to which the receiver is connected.
- Consult the dealer or an experienced radio/TV technician for help.

The device has been evaluated to meet general RF exposure requirement.

This equipment complies with FCC radiation exposure limits set forth for an uncontrolled environment. The antenna(s) used for this equipment must be installed and used in a separation distance of at least 20 cm from all persons.

IC warning

- English:

This device complies with Industry Canada licence-exempt RSS standard(s). Operation is subject to the following two conditions:

- (1) This device may not cause interference, and
- (2) this device must accept any interference, including interference that may cause undesired operation of the device.

- French:

Le présent appareil est conforme aux CNR d'Industrie Canada applicables aux appareils radio exempts de licence.

L'exploitation est autorisée

aux deux conditions suivantes:

- (1) l'appareil ne doit pas produire de brouillage, et
- (2) l'utilisateur de l'appareil doit accepter tout brouillage radioélectrique subi, même si le brouillage est susceptible d'en compromettre le fonctionnement.